

DRAWMER

MQ-2

Equaliser & Compressor for the 500 SERIES RACK SYSTEM

CONTENTS

Warranty	
Safety Consideration	3
Radio Frequencies Statement .	3
<i>Chapter 1 - Introduction</i>	
Introduction	4
Installation	5
Audio Connection	5
<i>Chapter 2 - Control Description</i>	
The MQ-2 Controls	6
Useful Frequencies	10
<i>Chapter 3 - General Information</i>	
If a fault develops	11
Contacting Drawmer	11
Specification	11
Block Diagram	12
Session Recall Sheet	13



DRAWMER

COPYRIGHT

This manual is copyrighted © 2025 by Drawmer Electronics Ltd. With all rights reserved. Under copyright laws, no part of this publication may be reproduced, transmitted, stored in a retrieval system or translated into any language in any form by any means, mechanical, optical, electronic, recording, or otherwise, without the written permission of Drawmer Electronics Ltd.

ONE YEAR LIMITED WARRANTY

Drawmer Electronics Ltd., warrants the Drawmer MQ-2 Equaliser and Compressor to conform substantially to the specifications of this manual for a period of one year from the original date of purchase when used in accordance with the specifications detailed in this manual. In the case of a valid warranty claim, your sole and exclusive remedy and Drawmer's entire liability under any theory of liability will be to, at Drawmer's discretion, repair or replace the product without charge, or, if not possible, to refund the purchase price to you. This warranty is not transferable. It applies only to the original purchaser of the product.

For warranty service please call your local Drawmer dealer. Alternatively call Drawmer Electronics Ltd. at +44 (0)1709 527574. Then ship the defective product, with transportation and insurance charges pre-paid, to Drawmer Electronics Ltd., Coleman Street, Parkgate, Rotherham, S62 6EL UK. Write the RA number in large letters in a prominent position on the shipping box. Enclose your name, address, telephone number, copy of the original sales invoice and a detailed description of the problem. Drawmer will not accept responsibility for loss or damage during transit.

This warranty is void if the product has been damaged by misuse, modification, unauthorised repair or installed with other equipment that proved to be faulty.

THIS WARRANTY IS IN LIEU OF ALL WARRANTIES, WHETHER ORAL OR WRITTEN, EXPRESSED, IMPLIED OR STATUTORY. DRAWMER MAKES NO OTHER WARRANTY EITHER EXPRESS OR IMPLIED, INCLUDING, WITHOUT LIMITATION, ANY IMPLIED WARRANTIES OF MERCHANTABILITY, FITNESS FOR A PARTICULAR PURPOSE, OR NON-INFRINGEMENT. PURCHASER'S SOLE AND EXCLUSIVE REMEDY UNDER THIS WARRANTY SHALL BE REPAIR OR REPLACEMENT AS SPECIFIED HEREIN. IN NO EVENT WILL DRAWMER ELECTRONICS LTD. BE LIABLE FOR ANY DIRECT, INDIRECT, SPECIAL, INCIDENTAL OR CONSEQUENTIAL DAMAGES RESULTING FROM ANY DEFECT IN THE PRODUCT, INCLUDING LOST PROFITS, DAMAGE TO PROPERTY, AND, TO THE EXTENT PERMITTED BY LAW, DAMAGE FOR PERSONAL INJURY, EVEN IF DRAWMER HAS BEEN ADVISED OF THE POSSIBILITY OF SUCH DAMAGES.

Some states and specific countries do not allow the exclusion of implied warranties or limitations on how long an implied warranty may last, so the above limitations may not apply to you. This warranty gives you specific legal rights. You may have additional

For the USA

FEDERAL COMMUNICATIONS COMMISSION RADIO FREQUENCY INTERFERENCE STATEMENT

This equipment has been tested and found to comply with the limits for a Class B digital device, pursuant to Part 15 of the FCC Rules. These limits are designed to provide reasonable protection against harmful interference in a residential installation. This equipment generates, uses and can radiate radio frequency energy and, if not installed and used in accordance with the instructions, may cause harmful interference to radio communications. However, there is no guarantee that interference will not occur in a particular installation. If this equipment does cause interference to radio or television reception, which can be determined by turning the equipment off an on, then the user is encouraged to try to correct the interference by one or more of the following measures:

Re-orient or relocate the receiving antenna.

Increase the separation between the equipment and the receiver.

Connect the equipment into an outlet on a circuit different from that to which the receiver is connected.

Consult the dealer or an experienced radio/TV technician for help.

Unauthorised changes or modification to this system can void the users' authority to operate this equipment. This equipment requires shielded interface cables in order to meet FCC class B limit.

For Canada

CLASS B NOTICE

This digital apparatus does not exceed the Class B limits for radio noise emissions set out in the Radio Interference Regulations of the Canadian Department of Communications.

CLASSE B AVIS

Cet appareil numérique ne dépasse pas les limites de la classe B au niveau des émissions de bruits radioélectriques fixés dans le Règlement des signaux parasites par le ministère Canadien des Communications.

SAFETY CONSIDERATIONS

CAUTION - SERVICING

DO NOT PERFORM ANY SERVICING. REFER ALL SERVICING TO QUALIFIED SERVICE PERSONNEL.

WARNING

TO REDUCE THE RISK OF FIRE OR ELECTRIC SHOCK DO NOT EXPOSE

THIS EQUIPMENT TO RAIN OR MOISTURE.

WARNING

PLEASE BE SURE TO POWER OFF YOUR 500 SERIES RACK BEFORE INSTALLING OR REMOVING THIS OR ANY OTHER 500 SERIES MODULE. HOT SWAPPING COULD CAUSE DAMAGE TO THIS OR OTHER EQUIPMENT.

In the interests of product development, Drawmer reserve the right to modify or improve specifications of this product at any time, without prior notice.



MQ=2

EQUALISER & COMPRESSOR FOR THE 500 SERIES RACK SYSTEM

Taking inspiration from the legendary 'Motown EQ', the MQ-2 is a stereo, 7 band proportional Q Equaliser with EQ curves akin to the renowned EQ's used in the illustrious Detroit studios in the 1960's. This 100% analogue EQ, features 7 bell curves, each having a variable cut/boost of $\pm 10\text{dB}$ and set at the beautifully musical frequencies of the original.

However, the MQ-2 is not only an EQ, it also incorporates a programme dependant, effortless to use one knob compressor that adapts its envelope to the characteristics of the signal.

But it doesn't stop there, in addition it incorporates the highly regarded 'CRUSH' feature present on the Drawmer 1971. When you activate the crush circuit, get ready for some pleasing harmonic saturation and that classic analogue warmth that adds a ton of character to any signal passing through the unit. The result? It fattens up the bass, adds presence to the mids, and brings a delightful shimmer to the top end. The harder you drive the EQ and compressor the more Crush you'll get! Using single controls for both channels it has never been easier to get the classic warm analogue sound you've been looking for.

Drawmer MQ-2 Features at a Glance:

- Stereo 7 band proportional Q Equaliser for 500 series.
- Inspired by the 1960's Motown EQ.
- Takes up two 500 series slots.
- Integrated 'CRUSH' feature that warms up your mix with harmonic saturation.
- Fully variable 10dB boost or cut.
- One knob Compressor to easily tame the levels.
- Swap EQ/Compressor in the signal path.
- Comprehensive metering
- Hard wired bypass.
- Designed and manufactured in the U.K.

INSTALLATION

Congratulations on purchasing your new Drawmer product. In order to protect your new investment, please take a few moments to fill out the warranty registration card provided in the box, or alternatively visit our website at www.drawmer.com and fill out the form online.

Quick and easy to do, registering your audio product is important and helps to serve as proof of ownership for any future warranty issues.

The MQ-2 does not function stand alone and requires the power supply and the audio connectors provided by an API 500 series compatible rack frame (not included).

Installing the MQ-2 into a 500 Series compatible rack.

1. Before you install anything be sure to turn off the 500 series rack and unplug it from the mains supply. The 500 Series have not been designed for 'hot swapping' and doing so could damage this and other products within the unit, making any warranty void.
2. After removing the MQ-2 from its packaging locate two free slots per MQ-2.
3. Whilst looking down into the 500 series rack ensure that the MQ-2 card edge connectors line up with the EDAC type connectors of the rack, then gently push the MQ-2 in place keeping it as square as possible until it is fully located. Do not use excessive force!
4. Tighten the four front panel screws.
5. Connect the XLR cables to the rear and power up the rack. The MQ-2 will power automatically and should be ready to use.

AUDIO CONNECTIONS

The inputs and outputs found on the back of the 500 rack are electronically balanced on conventionally wired XLRs (pin 1 screen, pin 2 hot, pin 3 cold and XLR shell is connected to chassis). The use of balanced wiring is recommended.

(Please consult your 500 series manual for further information).

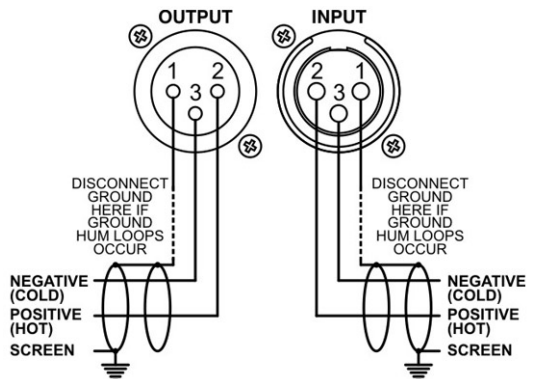

CONTROL DESCRIPTION

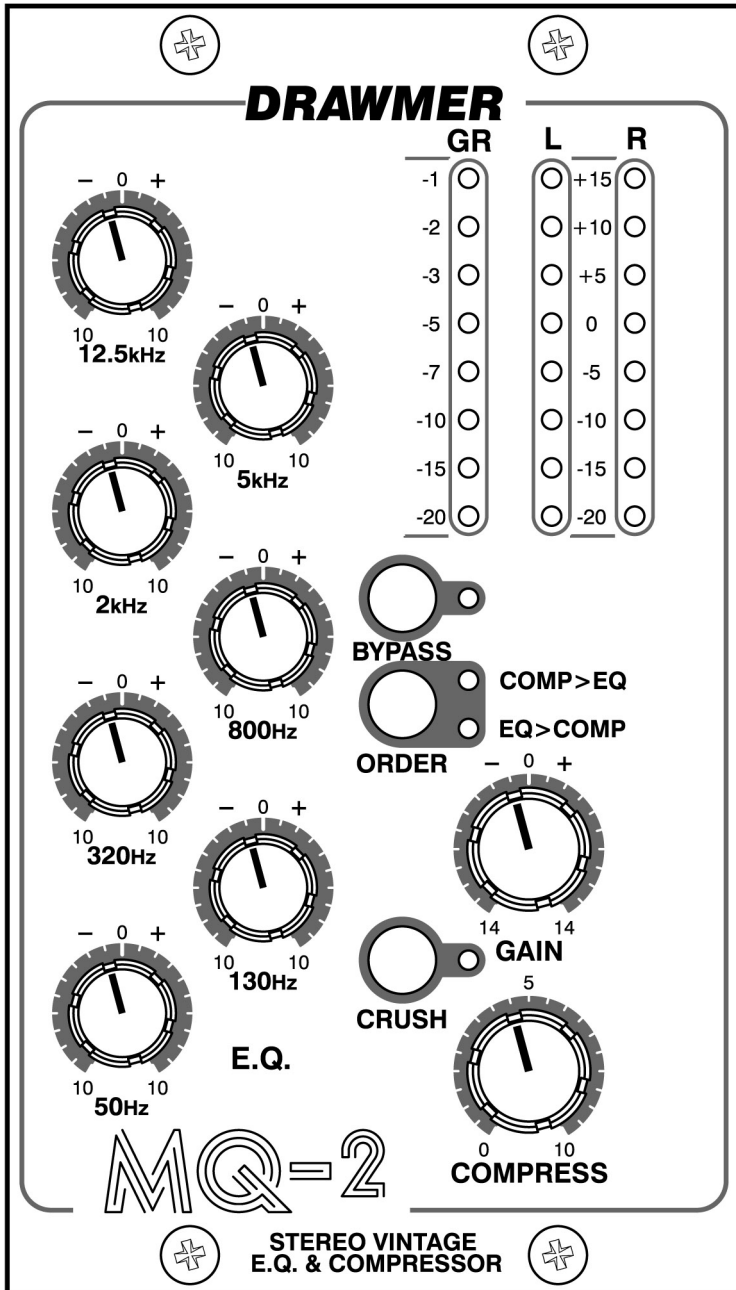

As the MQ-2 is stereo all controls effect the left and right settings simultaneously.

EQUALISER +10 to -10dB

There are seven fixed-frequency bell curve controls, set at the frequencies of the original equaliser used in the Motown studios, that allow broad cuts or boosts of up to 10dB:

12.5 kHz **BRILLIANCE**

This range is utilized for achieving a sparkling quality and adding airiness to the sound, but over-boosting can emphasize hiss and lead to ear fatigue.

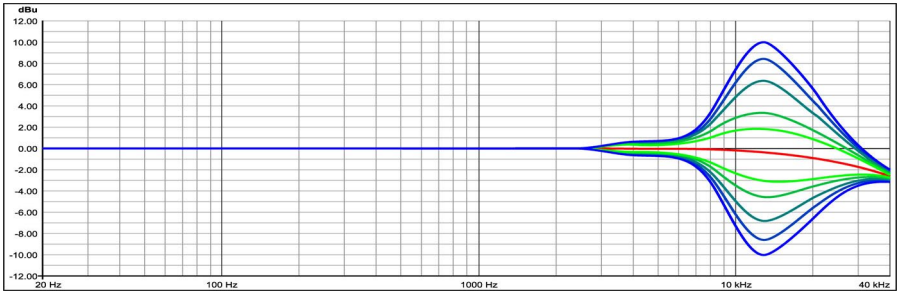

5 kHz **PRESENCE**

Boosting enhances clarity and gives signals an edge, but too much can make the sound abrasive, while a reduction may create a sense of distance.

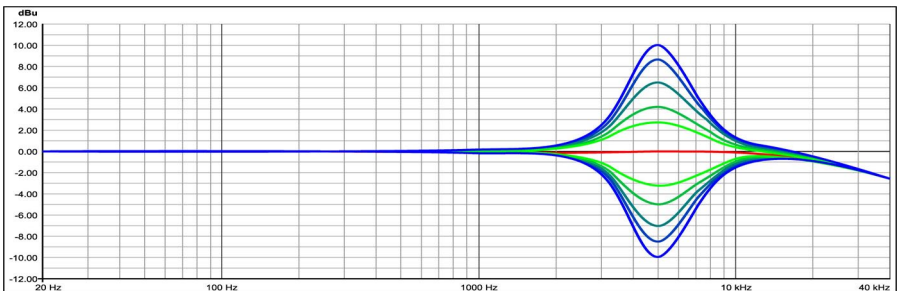

DRAWMER

2 kHz UPPER MIDRANGE

This frequency is crucial for enhancing the presence and definition of percussive hits and adding a crunchy character, but care must be taken to avoid ear fatigue from excessive boosting, so moderation is key.

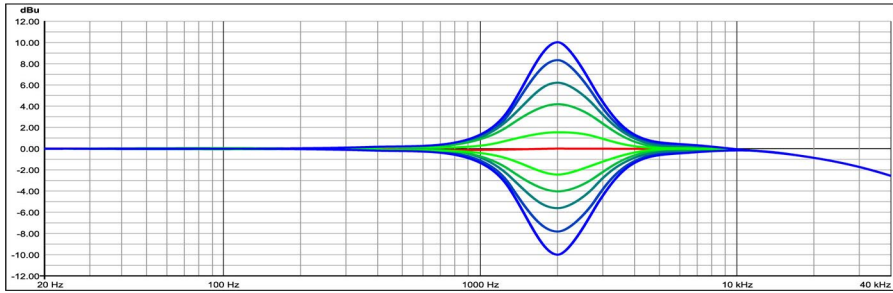

800 Hz MIDRANGE

Boosting this range improves the visibility of elements in a mix, though over-application can result in honkiness, leading to ear fatigue if not used judiciously.

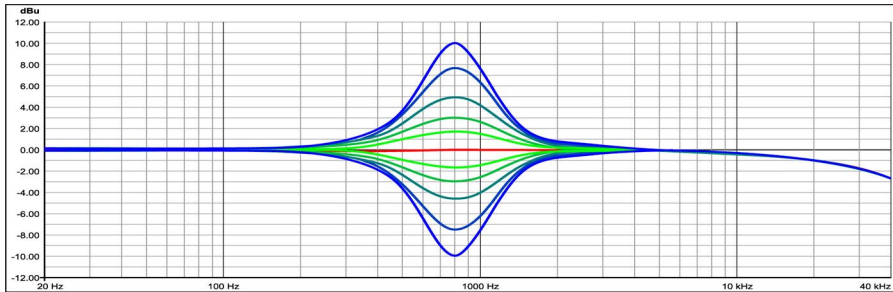

320 Hz LOW MIDRANGE

This frequency range is essential for adding bass presence, definition, and fullness. Too much can lead to a muddy sound, while too little results in a hollow perception.

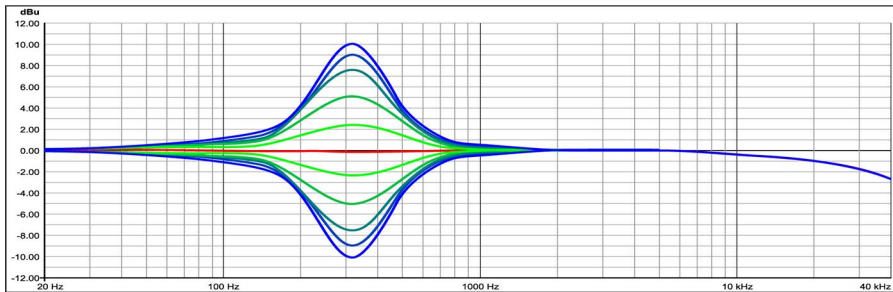

130 Hz

BASS

Boosting this area adds warmth and a deeper sound with enhanced thump; however, an excessive boost can create a boomy effect, while too little results in a thin sound.

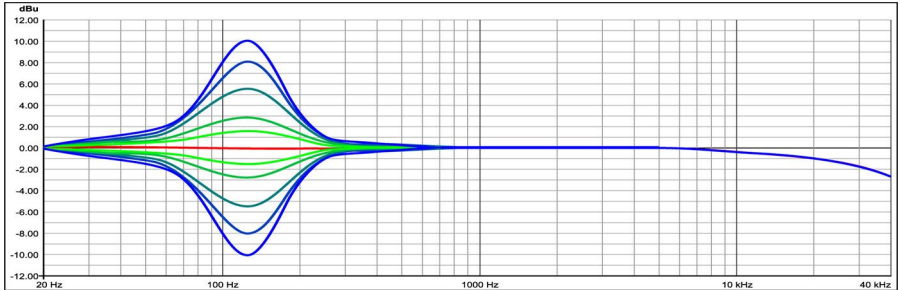

50 Hz

SUB-BASS

This frequency is typically felt rather than heard, imparting weight and a solid foundation that resonates in the chest, although care should be taken as it can amplify low-end rumble.

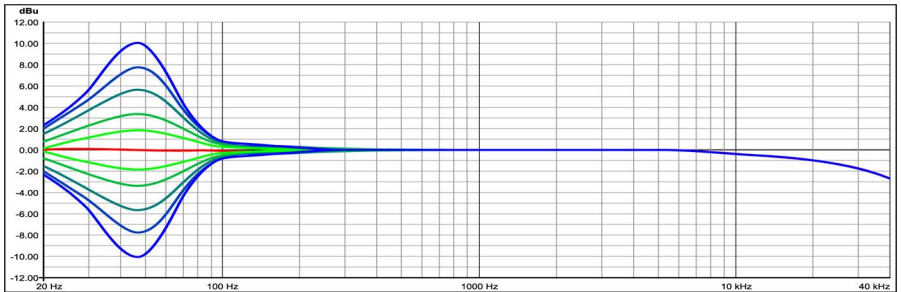

COMPRESS

0 to 10

Compression lowers the dynamic range of the signal and increases its perceived loudness and has an effect on the Crush. On the MQ-2 is applied using just one control! It is programme dependant so will adapt the attack and release characteristics to the signal and alter the envelope to suit.

At all the way counter-clockwise, you get no compression and the more you turn it up, the more compression you get.

DRAWMER

CRUSH On / Off

Adds a fixed time constant, auto gain makeup compressor and introduces some musically pleasing harmonics to each of the eq bands.

The effectiveness of the Crush button will vary depending on the frequency band that it is used in and also on the instrument that it is applied to. Use it in the lower frequencies to fatten up the kick, tom or snare drums, bass guitar and other elements of the rhythm section. In the mid frequencies it will help to warm the mix and enhance the presence. It will thicken the guitars and add punch to the percussion, increase the attack of a piano, as well as help to bring out the raspiness in a vocal, for example. At the high frequencies it will bring out the shimmer of cymbals and brighten the string instruments. The effect is progressive, so as more boost is added to the band the CRUSH effect is more apparent. If you wish to apply much more boost to a band in order to obtain more 'crush' be sure to keep an eye on the meters to ensure that the band level doesn't reach the rails, if so, the GAIN control can be used to reduce the levels. Use the switch to listen to A/B comparisons to hear the effectiveness of the feature.

GAIN +14 to -14dB

Adjust the Output Gain control to the required output level using the meter above as a guide. If you require more crush drive the Eq and Compressor harder then back off to the required output level using this control.

ORDER COMP>EQ / EQ>COMP

This switch allows the signal path to either route through the EQ first or the compressor first, as each way creates a distinctly different tonal quality, and colouration depending on the setting.

Note: A slight pop occurs when swapping the EQ and Compressor in the audio chain so it is recommended to reduce the gain whilst swapping.

BYPASS Switch

With the Bypass switch active the input signal is routed to the output with no signal processing taking place. Use it to provide A/B comparisons.

G.R. METER -1 -2 -3 -5 -7 -10 -15 -20 dB

An eight segment LED bargraph meter continuously monitors the gain reduction applied by the compressor over the range 0 to 30dB.

LEFT & RIGHT V.U. METER -20 -15 -10 -5 0 +5 +10 +15 dB

Two 8 segment LED bargraph level meters for the Left & Right level of the output signal over the range -20dB to +15dB.

USEFUL FREQUENCIES

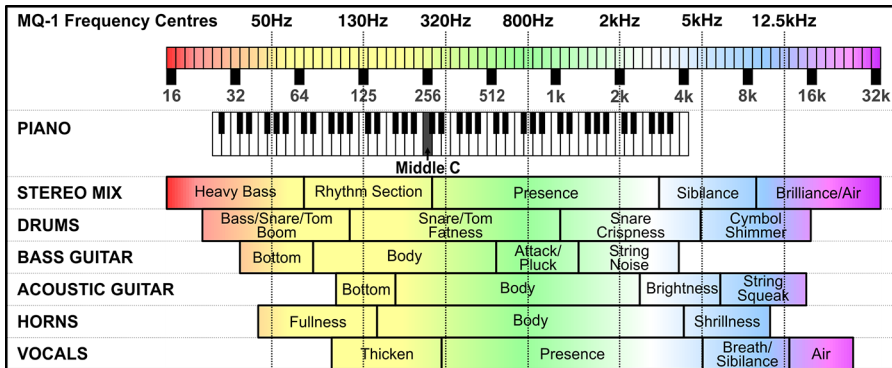

MQ-2 GENERAL INFORMATION**IF A FAULT DEVELOPS**

For warranty service please call Drawmer Electronics Ltd. or their nearest authorised service facility, giving full details of the difficulty.

A list of all main dealers can be found on the Drawmer webpages.

On receipt of this information, service or shipping instructions will be forwarded to you.

No equipment should be returned under the warranty without prior consent from Drawmer or their authorised representative.

For service claims under the warranty agreement a service Returns Authorisation (RA) number will be issued.

Write this RA number in large letters in a prominent position on the shipping box. Enclose your name, address, telephone number, copy of the original sales invoice and a detailed description of the problem.

Authorised returns should be prepaid and must be insured.

All Drawmer products are packaged in specially designed containers for protection. If the unit is to be returned, the original container must be used. If this container is not available, then the equipment should be packaged in substantial shock-proof material, capable of withstanding the handling for the transit.

CONTACTING DRAWMER

Drawmer Electronics Ltd., will be pleased to answer all application questions to enhance your usage of this equipment. Please address correspondence to:

Drawmer (Technical Help line)
Coleman Street
Parkgate
Rotherham
S62 6EL
UK

Alternatively contact us by E-mail on :
tech@drawmer.com

Further information on all Drawmer dealers, Authorised service departments and other contact information can be obtained from our web pages on:
<http://www.drawmer.com>

SPECIFICATION**INPUT**

Input Impedance	20K Ohms
Maximum Input Level	+16dBu

OUTPUT

Output Impedance	<100 Ohms
------------------	-----------

FREQUENCY RESPONSE

20Hz-20KHz	+/-0.5dB
------------	----------

% THD & NOISE

@1kHz ref 0dBu	0.01%
----------------	-------

NOISE AT UNITY GAIN ref 0dB,

Compression @ 0 20Hz-20KHz	-80dB
-------------------------------	-------

SIZE

Two 500 Series slots

WEIGHT

0.54kg

BLOCK DIAGRAM

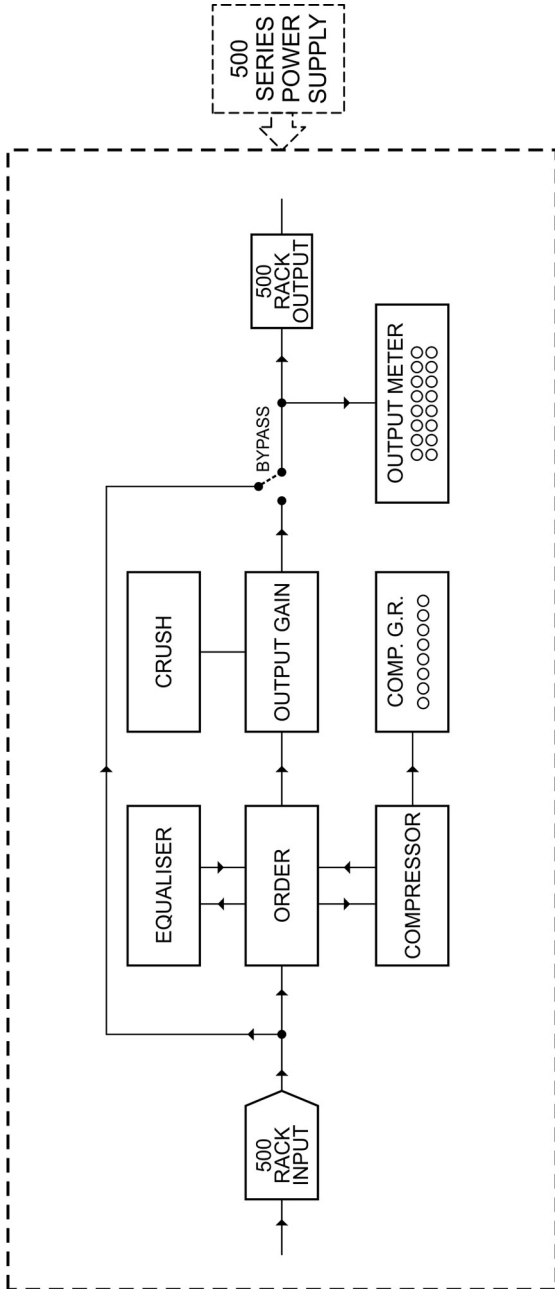

DRAWMER

MQ-2

Session Recall



DRAWMER



- 0 +

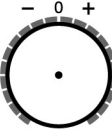

10 10
12.5kHz

- 0 +

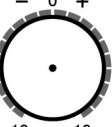

10 10
5kHz

- 0 +

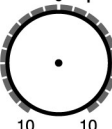

10 10
2kHz

- 0 +

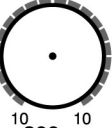

10 10
800Hz

- 0 +

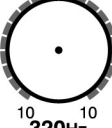

10 10
320Hz

- 0 +

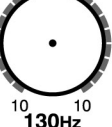

10 10
130Hz

- 0 +

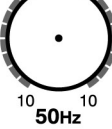

10 10
50Hz

E.Q.

GR

-1 ○

-2 ○

-3 ○

-5 ○

-7 ○

-10 ○

-15 ○

-20 ○

L

+15 ○

+10 ○

+5 ○

0 ○

-5 ○

-10 ○

-15 ○

-20 ○

R

+15 ○

+10 ○

+5 ○

0 ○

-5 ○

-10 ○

-15 ○

-20 ○

BYPASS

ORDER

COMP > EQ

EQ > COMP

- 0 +

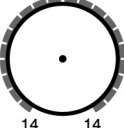

14 14
GAIN

5

CRUSH

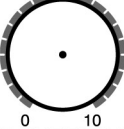

0 10
COMPRESS

MQ=2



STEREO VINTAGE
E.Q. & COMPRESSOR



Rack Details

Session No.

Date

Artist

Tape Location